

# Simultaneous Determination of Young's Modulus and Shear Modulus of Structural Lumber by Complex Vibrations of Bending and Twisting<sup>\*1</sup>

Nobuo SOBUE<sup>\*2</sup>

## 曲げ-ねじり複合振動による実大木材のヤング率とせん断弾性率の同時決定<sup>\*1</sup>

祖父江 信夫<sup>\*2</sup>

実大構造用木材のヤング率  $E$  とせん断弾性係数  $G$  を曲げ-ねじり複合振動によって同時決定する方法について検討した。木材の中央を発泡プラスチックの小片で弾性支持し、一端の角をハンマで軽く打撃すると、容易に曲げ-ねじり複合振動が励起された。他端の両角に配置した一対のマイクロフォン（又は加速度センサ）によって振動を検出し、その二つの信号を演算処理して和と差を求めると、複合信号から純粋な曲げ振動とねじり振動の信号を取り出すことができた。これらの信号を FFT アナライザに入力すると瞬間的に共振周波数を求められ、 $E$  と  $G$  を同時に決定することができた。チモシェンコの梁理論などから間接的に  $G$  を推定する方法も試みたが、節などの欠陥を有する実大構造材では、ねじり振動による直接測定が必要なことが明らかとなった。

The determination of the Young's modulus ( $E$ ) and the shear modulus ( $G$ ) of structural lumber by a vibration method was examined.

Complex vibrations of bending and twisting were produced by tapping a piece of lumber with a hard-rubber hammer.

The isolation of the time-deflection signals of bending and twisting vibrations from the signal of a complex vibration was made by performing an addition to and a subtraction from the complex signals which were detected by a pair of vibration sensors installed at both edges of an end of a piece of lumber.

The isolated signals were introduced to a Fast Fourier Transformation spectrum analyzer, and the resonance frequencies were identified instantaneously.

This proposed method enabled a simultaneous determination of the  $E$  and  $G$  of structural lumber.

*Keywords*: structural lumber, Young's modulus, shear modulus, simultaneous measurement, vibration method.

### 1. INTRODUCTION

In the structural design of wood construction, not only the strength of structural elements but also their

stiffness are important. Usually design sizes of wooden beams are controlled by their stiffness. For this stiffness design, not only a Young's modulus ( $E$ ) but also a shear modulus ( $G$ ) are needed, especially in deep beams, because the effect of the deflection caused by a shear deformation can not be ignored.

The current method of machine-stress-rating (MSR) dimension lumber is intended to measure  $E$ . Concerning a  $G$  measurement, the standard procedure

<sup>\*1</sup> Received December 3, 1987. This work was presented at the 37th Annual Meeting of the Japan Wood Research Society in 1987 (held at Kyoto).

<sup>\*2</sup> 名古屋大学農学部 School of Agriculture, Nagoya University, Chikusa-ku, Nagoya 464

of a static torsion test for structural lumber has been recommended in the American Society for Testing and Materials (ASTM) D 198,<sup>1)</sup> but this method is not conveniently applied in lumber mills and factories.

This work aims at development of a vibration method for measuring the *E* and *G* of structural lumber simultaneously. A proposed tapping method using a Fast Fourier Transformation (FFT) spectrum analyzer would enable an instantaneous measurement of both in lumber mills.

## 2. FUNDAMENTALS OF COMPLEX VIBRATIONS OF BENDING AND TWISTING

A beam tapped at an eccentric position, such as along an edge line, produces complex vibrations of bending and twisting. Here, the bending vibration and the twisting vibration occur independently because the beam's cross-section is rectangular.

Figure 1 (a) shows a frequency spectrum of a complex vibration of a piece of 2" by 4" lumber which was tapped along its edge line. The identification of resonance peaks of the bending vibration marked by B-*n* can be made easily from a comparison of each peak with that of the pure bending vibration.

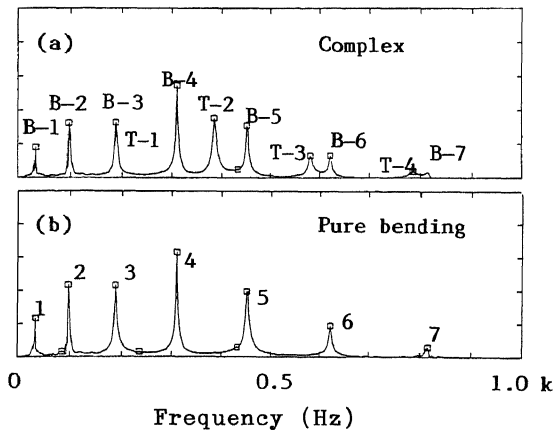

Fig. 1. Frequency spectra of a complex vibration (a) and a pure bending vibration (b) of a piece of 2" by 4" lumber.

Notes: B-*n*: resolved peak of bending vibration of *n*-th vibration mode. T-*n*: resolved peak of twisting vibration of *n*-th vibration mode. The T-1 peak is found at the right shoulder of the B-3 peak.

A pure bending vibration occurs when a piece of lumber is tapped along its center line (Figure 1 (b)). The identification of resonance peaks of the twisting vibration marked by T-*n* is made by assigning the remaining peaks, which are located at a constant frequency interval, to each mode in the order of frequency.

However, sometimes the two resonance peaks of bending and twisting vibrations are located very closely together as shown in Figure 1 (a). This leads to misidentifications of the resonance peaks.

The following procedure which is intended to isolate the time-deflection signals of bending and twisting vibrations from that of a complex vibration gives a substantial solution for these misidentifications. Figure 2 shows the concept of this procedure.

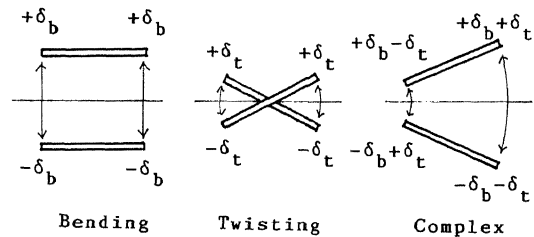

Fig. 2. The displacement of a beam in different vibration modes.

The displacement of a beam at the two edges of an end in complex vibration become  $\delta_b + \delta_t$  and  $\delta_b - \delta_t$ , where  $\delta_b$  and  $\delta_t$  are the components of the deflections of a beam at any time in bending and in twisting vibrations, respectively. Accordingly, the addition and the subtraction of the displacements at the two edges of an end in a complex vibration provide the doublings of the deflections of the pure bending vibration and of the twisting vibration, respectively.

$$\text{Addition: } (\delta_b + \delta_t) + (\delta_b - \delta_t) = 2\delta_b,$$

$$\text{Subtraction: } (\delta_b + \delta_t) - (\delta_b - \delta_t) = 2\delta_t.$$

These operations were made electronically by using operational amplifiers as shown in Figure 3.

## 3. EXPERIMENTS

### 3.1 Materials

Eighty pieces of No. 1 dry Spruce-Pine-Fire (S-P-F) lumber each 10 feet long (that is, twenty pieces for each 2" by 4", 2" by 6", 2" by 8", and 2" by 10" dimension size) and two timbers for a traditional

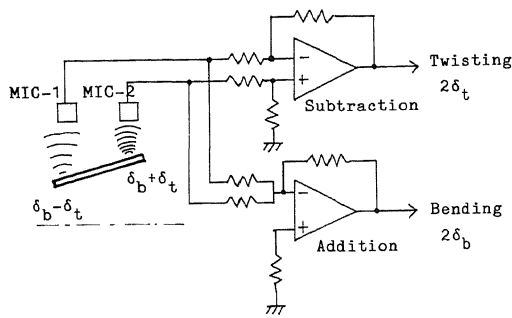

Fig. 3. Diagram of the operational amplifiers used for the addition and subtraction of signals.

Japanese house (10.5 cm × 10.5 cm × 3 m; western hemlock) were used. A part of the experiments was made with 2" by 4" S-P-F lumber, 8 feet long.

### 3.2 Methods

Specimens were supported horizontally or vertically on an iron block which was installed at the center of a beam. A sheet of 2 mm rubber or a piece of foamed polystyrene, 5 cm thick, was placed between a beam and the iron block.

Specimens were tapped with a hard-rubber hammer at two positions along their edge line: at an end and at a point located one-quarter of the length from the end. The first position was tapped because it coincided with the loop of all vibration modes, and the second position was tapped to enhance the response peaks of the higher-numbered vibration modes.

Tap tones were detected by a pair of condenser microphones which were installed at the other end of the beam. The detection of vibration also was tried by using a pair of acceleration sensors instead of the microphones.

A spectrum analysis was made by using a FFT spectrum analyzer (Ono Sokki Co.; dual-channels analyzer CN-910).

$E$  and  $G$  were calculated from the vibration theory of free-free bending<sup>2)</sup> and free-free twisting<sup>3)</sup> vibrations of a beam.

## 4. RESULTS AND DISCUSSIONS

Figure 4 shows the frequency spectra of the resolved bending vibrations when a 2" by 4" piece of lumber was supported horizontally on a rubber sheet and on a foamed polystyrene piece. For the former, the vibrations of even-numbered modes were ob-

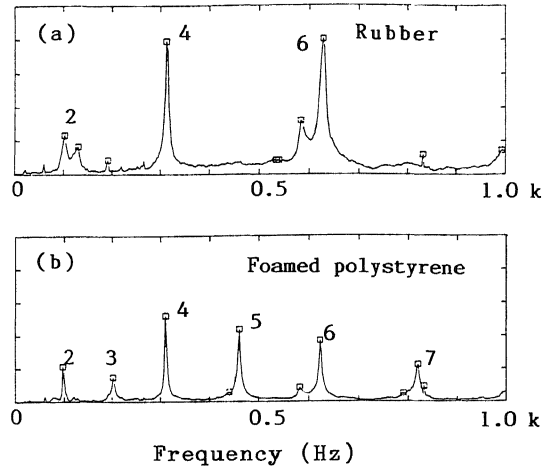

Fig. 4. Frequency spectra of the resolved bending vibrations.

Notes: A 2" by 4" piece of lumber was supported horizontally. (a): supported on a rubber sheet. (b): supported on a foamed polystyrene piece.

served (Figure 4(a)). However, for the latter, not only the vibrations of even-numbered modes but also those of odd-numbered modes were observed (Figure 4(b)). This proved that the elastic support by the foamed polystyrene piece provided but a weak restraint of the vibrations of the odd-numbered modes.

Figure 5 shows the spectra of the resolved twisting vibrations. In the case of the support on a rubber sheet, only vibrations of odd-numbered modes were observed because the support position of a beam coincides with the nodal points of the odd-numbered mode vibrations. By using a foamed polystyrene piece, the vibrations of even-numbered modes also were observed.

Figure 4 and 5 show that the two-times tapping excites the vibration of structural lumber effectively. No remarkable differences of spectrum patterns were observed between a horizontal supporting and a vertical supporting of a beam. It was concluded that the horizontal supporting of a beam was better than vertical supporting because of the stability and the ease of support.

In the case of a post for a traditional Japanese house, a specimen was supported on a formed polystyrene piece. The fundamental mode of a bending vibration also was observed.

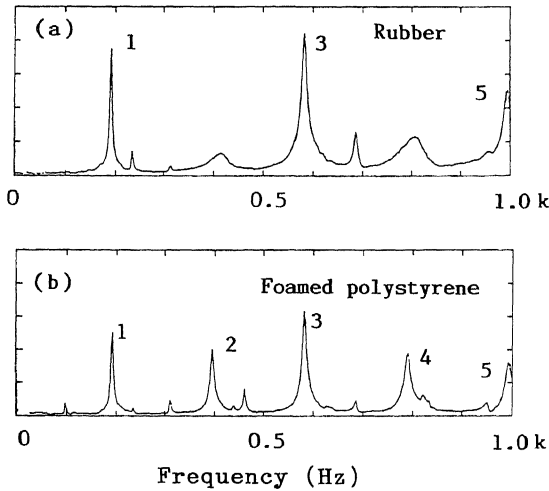

Fig. 5. Frequency spectra of the resolved twisting vibrations.  
 Notes: A 2" by 4" piece of lumber was supported horizontally. (a): supported on a rubber sheet. (b): supported on a foamed polystyrene piece.

It was concluded that a beam horizontally supported on a foamed polystyrene piece provided for the

preferable vibration of structural lumber.

We noted that sudden high-level noise in lumber mills disturbed the detection by microphones of vibration sounds. To correct this condition, a vibration measurement using acceleration sensors of piezo-crystal was examined. A pair of acceleration sensors was attached on both edges of an end of a beam by pieces of sticky tape. However, no significant differences in spectra were observed between the two detection methods.

Detection of signals by microphones is convenient because non-contact measurements are possible. On the other hand, a vibration detected by acceleration sensors is a little troublesome because it requires the mounting of sensors on a specimen for every measurement. However, the latter technique being more reliable under noisy circumstances as in lumber mills, it was used in the following experiments.

Figure 6 shows the typical spectra of dimension lumber of all sizes used. Fairly good isolations of the resonance peaks of bending vibrations and twisting vibrations were obtained.

The identification of resonance peaks of twisting

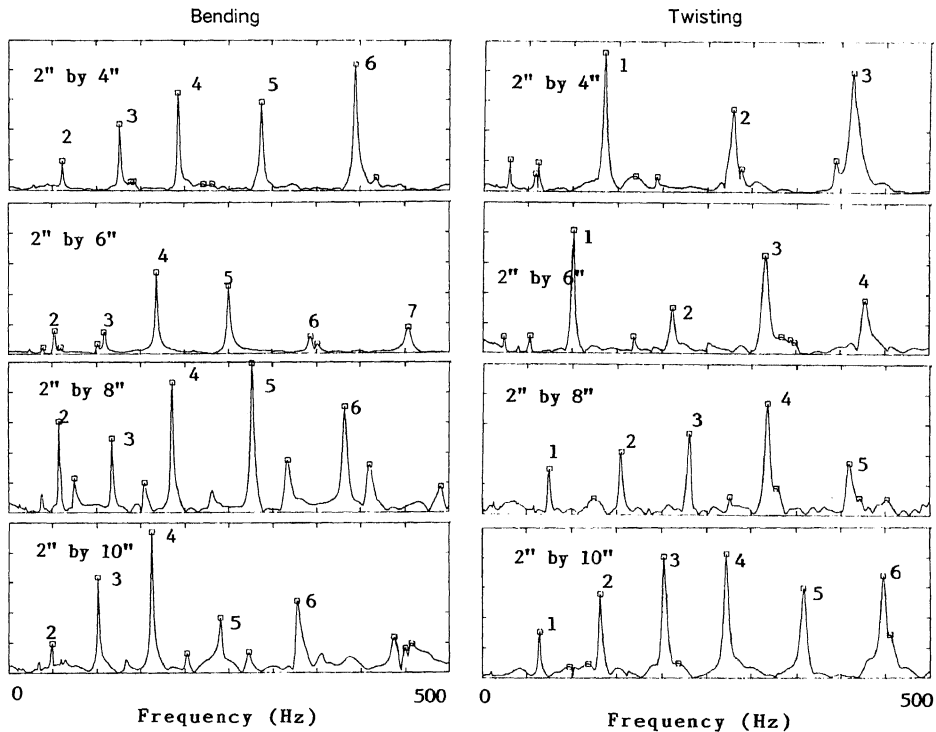

Fig. 6. Typical spectra of dimension lumber of all sizes used.

vibrations was made easily because their response levels were superior and each peak appeared at a constant frequency interval.

The identification of the resonance peaks of bending vibrations was a little complicated. Sometimes weak resonance peaks due to twisting vibrations contaminated the spectrum of the resolved bending vibrations because of the imperfect signal isolation which was caused by defects in specimens such as local dispersions of fiber arrangements and knots. However, identification could be made with the aid of information about the regularity of resonance frequencies which were calculated from the vibration theory.

Identification was begun with attention to the resonance peak of the 4th-mode vibrations because its response level was superior. Indeed, arranging the response peaks in the order of their response levels in each spectrum, the magnitude of the response level of the 4th-mode vibration was greater than that of the peak 5th from the maximum peak.

First, a provisional value of the resonance frequency of the 4th-mode vibration was calculated from an  $E$  reported in literature. Then, the largest peaks located near this provisional resonance frequency were sought, and an improved  $E$  was calculated. Here, the resonance frequencies of other-numbered vibration modes were estimated. If the best-fitted peaks were not obtained, the assumed resonance frequency of the 4th-mode vibration had to be corrected and the same procedure repeated until a best-fitted search was obtained. As the limit of this work was on eighty pieces of S-P-F lumber, no correction for the first choice of the 4th-mode resonance peak was needed.

The support conditions of a beam affect the observed resonance frequencies which are used for the calculation of  $E$  and  $G$ .

Figure 7 shows the shift of the resonance frequency of the resolved bending vibration from that of the pure free-free bending vibration. Here, a free-free beam was supported at nodal points of the vibration. The dashed line represents the inherent error caused by the operation of the FFT analyzer used. The errors at odd-numbered modes, especially at the 3rd mode, were greater than those at even-numbered mode vibrations because of the support conditions of

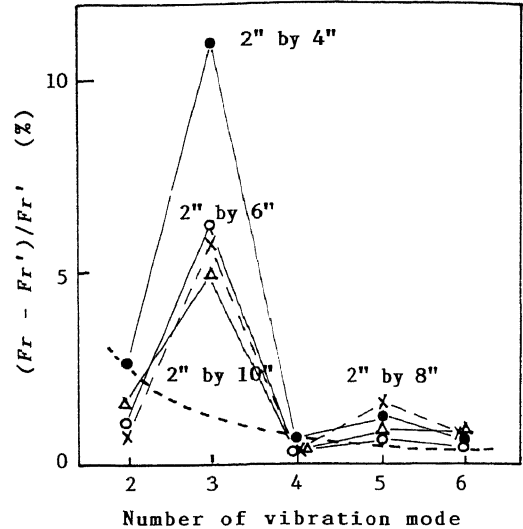

Fig. 7. Effect of the support of a beam on the resonance frequency of the resolved bending vibration.

Notes:  $Fr$ : resonance frequency obtained from the resolved spectrum.  $Fr'$ : resonance frequency obtained from the free-free vibration.

the beam. Therefore, an  $E$  was calculated from the resonance frequencies of the 2nd, 4th, and 6th mode vibrations in this work.

Figure 8 shows the plots of the  $G$  ratio,  $G_n/G$ , with respect to the mode number;  $G$ , a  $G$  calculated from the resonance frequency of the fundamental mode vibration; and  $G_n$ , a  $G$  calculated from that of the  $n$ -th mode vibration. The ratio increased with

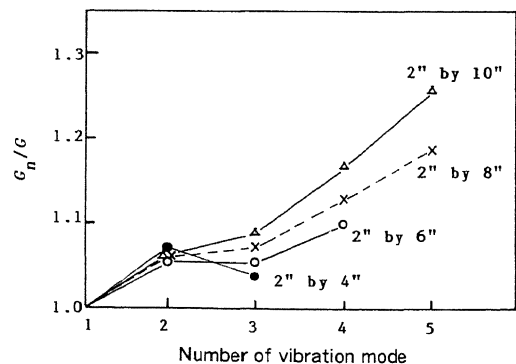

Fig. 8. Relationship between  $G$  ratio  $G_n/G$  and number of vibration mode.

Notes:  $G_n$ :  $G$  calculated from the resonance frequency of the  $n$ -th vibration mode.  $G$ :  $G$  calculated from the resonance frequency of the fundamental vibration mode.

increases of the mode number, and it also increased with increases of the width-to-thickness ratio of a beam,  $b/h$ . These trends occur because of the "warp" effect in twisting vibrations. The same phenomenon has been reported by Nakao and others in the case of the twisting vibrations of clear short beams.<sup>4)</sup> A little greater increase in the 2nd mode vibration was due to the restraint of the vibration caused by the support of a beam. Therefore,  $G$  values were calculated from the resonance frequencies of fundamental vibrations; this also has been recommended by Nakao and others.<sup>4)</sup>

The correlation between  $G$  and  $E$  was examined to confirm if  $G$  can be estimated indirectly from  $E$ . However, the result of a linear-regression analysis did not give significant correlation,

$$G = 0.76 - 6.73 \times 10^{-3} E \quad (\text{GPa}),$$

$$r = 0.107.$$

Another indirect estimation of  $G$  by the flexural vibration theory of Timoshenko's beam also was examined. Its calculated values,  $G_f$ , were plotted with

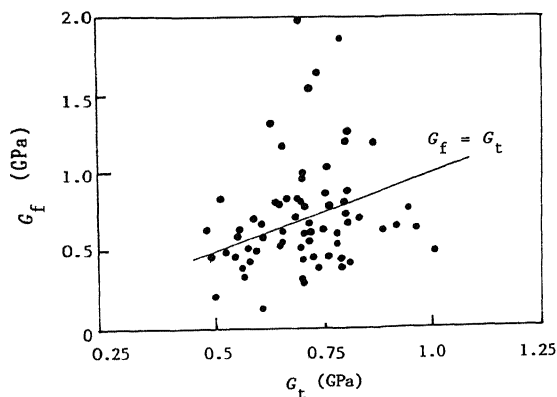

Fig. 9. Relationship between shear moduli  $G_f$  and  $G_t$ .

Notes:  $G_f$ :  $G$  calculated by the flexural vibration theory of Timoshenko's beam.  $G_t$ :  $G$  calculated by the twisting vibration theory.

respect to those obtained from the twisting vibration,  $G_t$ , in Figure 9. The data was scattered about the straight line which represents  $G_f = G_t$ . Unlike a previous study on clear short beams,<sup>5)</sup> the plotted data showed scattering beyond expectations. This difference probably occurred from the existence of defects in the lumber which agitated the resonance frequencies of beams.

Our results prove the necessity of a direct twisting test for the measurement of the  $G$  of commercial timbers.

## 5. CONCLUSIONS

The proposed tapping method using complex vibrations of bending and twisting of free-free beams enabled a simultaneous determination of an  $E$  and a  $G$  of structural lumber. This method also enabled a simple arrangement of devices which would be preferable for the quality evaluation of structural lumber in lumber mills and factories.

The results of the indirect estimations of  $G$  by the flexural vibration theory of Timoshenko's beam and by the regression analysis of  $G$  and  $E$  proved that a twisting vibration method was indispensable for measuring the  $G$  of structural lumber.

## REFERENCES

- 1) American Society for Testing and Material: "Annual Book of ASTM Standards", Section 4, 1984, p. 108.
- 2) Hearmon, R. F. S.: *Br. J. Appl. Phys.*, **9**, 381-388 (1958).
- 3) Timoshenko, S. P.: "Vibration Problems in Engineering", Tokyo Tosho, 1978, p. 293.
- 4) Nakao, T.; Okano, T.; Asano, I.: *Mokuzai Gakkaishi*, **31** (6), 435-439 (1985).
- 5) Sobue, N.: *ibid.*, **32** (4), 274-279 (1986).